

KENWOOD

GRAPHIC EQUALIZER

KE-894

KE-2060

---

INSTRUCTION MANUAL

KENWOOD CORPORATION

This manual contains instructions for two models.

# Introduction

Your choice of this product indicates that you are a devotee to excellence in sound reproduction.

We appreciate your patronage and take pride in the long tradition of quality components that our company represents.

So that you can get the most out of your unit, we suggest that you take the time to read through this manual before you hook up and operate your system. This will acquaint you with operating features and system-connection considerations so that your listening pleasure will be enhanced right from the start. You will notice that in all aspects of planning, engineering, styling, operating convenience and adaptability we have sought to anticipate your needs and desires.

**Keep this manual handy for future reference.**

## For your records

Record the serial number, found on the back of the unit, in the spaces designated on the warranty card, and in the space provided below. Refer to the model and serial numbers whenever you call upon your dealer for information or service on this product.

Model \_\_\_\_\_ Serial Number \_\_\_\_\_

## Unpacking

Unpack the unit carefully and make sure that all accessories are put aside so they will not be lost.

Examine the unit for any possibility of shipping damage. If your unit is damaged or fails to operate, notify your dealer immediately. If your unit was shipped to you directly, notify the shipping company without delay. Only the consignee (the person or company receiving the unit) can file a claim against the carrier for shipping damage.

We recommend that you retain the original carton and packing materials for use should you transport or ship the unit in the future.

## Accessories

Audio cord ..... 2



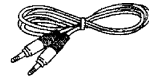

System control cord ..... 1



## Contents

Caution: Read the pages marked  carefully to ensure safe operation.

Introduction .....	2	Operating instructions .....	9
 Before applying power .....	3	Using the equalizer effect .....	9
 Safety precautions .....	3	Equalizer pattern list .....	10
 IMPORTANT SAFEGUARDS .....	4	Storing your own patterns .....	12
System connections .....	6	How to play tape with equalizer effect .....	13
Controls and indicators .....	8	In case of difficulty .....	14
		Specifications .....	15

## Before applying power

 **Caution: Read this page carefully to ensure safe operation.**

### For the U.S.A. Mexico and Canada

#### Important!

Units shipped to the U.S.A., Mexico and Canada are designed for operation on 120 volts AC only.

### For Australia and Europe

#### Important!

Units shipped to Australia are designed for operation on 240 Volts AC only.  
Units shipped to Europe are designed for operation on 230 Volts AC only.

### For the United Kingdom

#### Important!

Units shipped to the U.K. are designed for operation on 240 volts AC only.

#### Factory fitted moulded mains plug

1. The mains plug contains a fuse. For replacement, use only a 3-Amp ASTA-approved (BS1362) fuse.
2. The fuse cover must be refitted when replacing the fuse in the moulded plug.
3. Do not cut off the mains plug from this equipment. If the plug fitted is not suitable for the power points in your home, or the cable is too short to reach a power point, then obtain an appropriate safety approved extension lead or adaptor, or consult your dealer. If nonetheless the mains plug is cut off, remove the fuse and dispose of the plug immediately, to avoid a possible shock hazard by inadvertent connection to the mains supply.

### For other countries

#### Important!

Units shipped to countries other than the above countries are equipped with an AC voltage selector switch on the rear panel. Refer to the following paragraph for the proper setting of this switch.

#### AC voltage selection

This unit operates on 110 - 120 volts or 220 - 240 volts AC. The AC voltage selector switch on the rear panel is set to the voltage that prevails in the area to which the unit is shipped. Before connecting the power cord to your AC outlet, make sure that the setting position of this switch matches your line voltage. If not, it must be set to your voltage in accordance with the following direction.



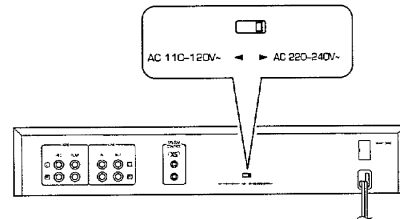

#### AC voltage selector switch



Note:  
Our warranty does not cover damage caused by excessive line voltage due to improper setting of the AC voltage selector switch.

## Safety precautions

**WARNING :** TO PREVENT FIRE OR ELECTRIC SHOCK, DO NOT EXPOSE THIS APPLIANCE TO RAIN OR MOISTURE.

 <b>CAUTION</b> RISK OF ELECTRIC SHOCK DO NOT OPEN	 <p>CAUTION: TO REDUCE THE RISK OF ELECTRIC SHOCK, DO NOT REMOVE COVER (OR BACK). NO USER-SERVICEABLE PARTS INSIDE, REFER SERVICING TO QUALIFIED SERVICE PERSONNEL.</p>
	<p>THE LIGHTNING FLASH WITH ARROWHEAD SYMBOL, WITHIN AN EQUILATERAL TRIANGLE, IS INTENDED TO ALERT THE USER TO THE PRESENCE OF UNINSULATED "DANGEROUS VOLTAGE" WITHIN THE PRODUCT'S ENCLOSURE THAT MAY BE OF SUFFICIENT MAGNITUDE TO CONSTITUTE A RISK OF ELECTRIC SHOCK TO PERSONS.</p>
	<p>THE EXCLAMATION POINT WITHIN AN EQUILATERAL TRIANGLE IS INTENDED TO ALERT THE USER TO THE PRESENCE OF IMPORTANT OPERATING AND MAINTENANCE (SERVICING) INSTRUCTIONS IN THE LITERATURE ACCOMPANYING THE APPLIANCE.</p>

# IMPORTANT SAFEGUARDS

 **Caution: Read this page carefully to ensure safe operation.**

Please read all of the safety and operating instructions before operating this appliance. Adhere to all warnings on the appliance and in the instruction manual. Follow all the safety and operating instructions. These safety and operating instructions should be retained for future reference.

- 1. Power sources** – The appliance should be connected to a power supply only of the type described in the instruction manual or as marked on the appliance. If you are not sure of the type of power supply to your home, consult your appliance dealer or local power company. For appliances intended to operate from battery power, or other sources, refer to the instruction manual.
- 2. Power-cord protection** – Power-supply cords should be routed so that they are not likely to be walked on or pinched by items placed upon or against them, paying particular attention to cords at plugs, convenience receptacles, and the point where they exit from the appliance.

Never pull or stretch the cord.



- 3. CAUTION – Polarization** – This appliance may be equipped with a polarized alternating-current line plug (a plug having one blade wider than the other). This plug will fit into the power outlet only one way. This is a safety feature. If you are unable to insert the plug fully into the outlet, try reversing the plug. If the plug should still fail to fit, contact your electrician to replace your obsolete outlet. Do not defeat the safety purpose of the polarized plug.
- 4. Ventilation** – Slots and openings in the cabinet are provided for ventilation and to ensure reliable operation of the appliance and to protect it from overheating, and these openings must not be blocked or covered. The appliance should be situated so that its location or position does not interfere with its proper ventilation. To maintain good ventilation, do not put records or a tablecloth on the appliance. Place the appliance at least 10 cm away from the walls. Do not use the appliance on a bed, sofa, rug or similar surface that may block the ventilation openings. This appliance should not be placed in a built-in installation such as a bookcase or rack unless proper ventilation is provided or the manufacturer's instructions have been adhered to.

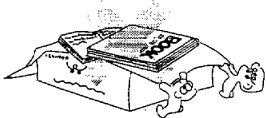

- 5. Water and moisture** – The appliance should not be used near water - for example, near a bathtub, washbowl, kitchen sink, laundry tub, in a wet basement, or near a swimming pool, etc.

- 6. Temperature** – The appliance may not function properly if used at extremely low, or freezing temperatures. The ideal ambient temperature is above +5°C (41°F).
- 7. Heat** – The appliance should be situated away from heat sources such as radiators, heat registers, stoves, or other appliances (including amplifiers) that produce heat.
- 8. Electric shock** – Care should be taken so that objects do not fall and liquid is not spilled into the enclosure through openings. If a metal object, such as a hair pin or a needle, comes into contact with the inside of this appliance, a dangerous electric shock may result. For families with children, never permit children to put anything, especially metal, inside this appliance.

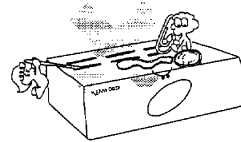

- 9. Enclosure removal** – Never remove the enclosure. If the internal parts are touched accidentally, a serious electric shock might occur.

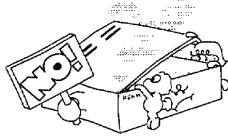

- 10. Magnetic fields** – Keep the appliance away from sources of magnetic fields such as TV sets, speaker systems, radios, motorized toys or magnetized objects.
- 11. Cleaning** – Unplug this appliance from the wall outlet before cleaning. Do not use volatile solvents such as alcohol, paint thinner, gasoline, or benzene, etc. to clean the cabinet. Use a clean dry cloth.
- 12. Accessories** – Do not place this appliance on an unstable cart, stand, tripod, bracket, or table. The appliance may fall, causing serious injury to a child or adult, and serious damage to the appliance. Use only with a cart, stand, tripod, bracket, or table recommended by the manufacturer, or sold with the appliance. Any mounting of the appliance should follow the manufacturer's instructions, and should use a mounting accessory recommended by the manufacturer. An appliance and cart combination should be moved with care. Quick stops, excessive force, and uneven surfaces may cause the appliance and cart combination to overturn.



**Caution : Read this page carefully to ensure safe operation.**

**13. Lightning** – For added protection for this appliance during a lightning storm, or when it is left unattended and unused for long periods of time, unplug it from the wall outlet and disconnect the antenna or cable system. This will prevent damage to the appliance due to lightning and power-line surges.

**14. Abnormal smell** – If an abnormal smell or smoke is detected, immediately turn the power OFF and unplug the appliance from the wall outlet. Contact your dealer or nearest service center.

**POWER OFF!**

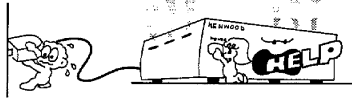

**15. Damage requiring service** – The appliance should be serviced by qualified service personnel when:

- A. The power-supply cord or the plug has been damaged.
- B. Objects have fallen, or liquid has been spilled into the appliance.
- C. The appliance has been exposed to rain or water.
- D. The appliance does not appear to operate normally by following the instruction manual. Adjust only those controls that are covered by the instruction manual as an improper adjustment of other controls may result in damage and will often require extensive work by a qualified technician to restore the appliance to its normal operation.
- E. The appliance has been dropped, or the enclosure damaged.
- F. The appliance exhibits a marked change in performance.

**16. Servicing** – The user should not attempt to service the appliance beyond that described in the instruction manual. All other servicing should be referred to qualified service personnel.

**17. Outdoor antenna grounding** – If an outside antenna is connected to the appliance, be sure the antenna system is grounded so as to provide some protection against voltage surges and built up static charges. Article 810 of the National Electrical Code ANSI/NFPA 70, provides information with respect to proper grounding of the mast and supporting structure, grounding of the lead-in wire to an antenna discharge unit, size of grounding conductors, location of antenna discharge unit, connection to grounding electrodes, and requirements for the grounding electrode. See Figure.

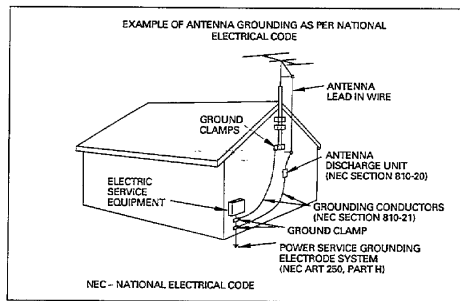

**18. Power lines** – An outside antenna system should not be located in the vicinity of overhead power lines or other electric light or power circuits, or where it can fall into such power lines or circuits. When installing an outside antenna system, extreme care should be taken to keep from touching such power lines or circuits as contact with them might be fatal.

**19. AC outlets** – Do not connect other audio equipment with a power consumption larger than that specified to the AC outlet on the rear panel. Never connect other electrical appliances, such as an iron or toaster, to it to prevent fire or electric shock.

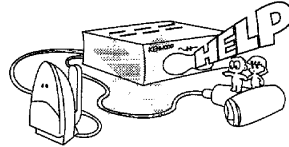

**20. Overloading** – Do not overload wall outlets, extension cords, or integral convenience receptacles as this can result in a risk of fire or electric shock.

**21. Attachment** – Do not use attachments not recommended by the appliance manufacturer as they may cause hazards.

**22. Replacement parts** – When replacement parts are required, be sure the service technician has used replacement parts specified by the manufacturer or have the same characteristics as the original parts. Unauthorized substitutions may result in fire, electric shock, or other hazards.

**23. Safety check** – Upon completion of any service or repairs to this appliance, ask the service technician to perform safety checks to determine that the appliance is in proper operating condition.

Notes:

- 1. Item 3 is not required except for grounded or polarized equipment.
- 2. Item 17 and 18 are not required except for units provided with antenna terminals.
- 3. Item 17 complies with UL in the U.S.A.

# System connections

Make connections as shown below. When connecting the related system components, refer also to the instruction manuals of the related components.  
Do not plug in the power lead until all connections are completed.

## ■ Connecting to amplifier or receiver

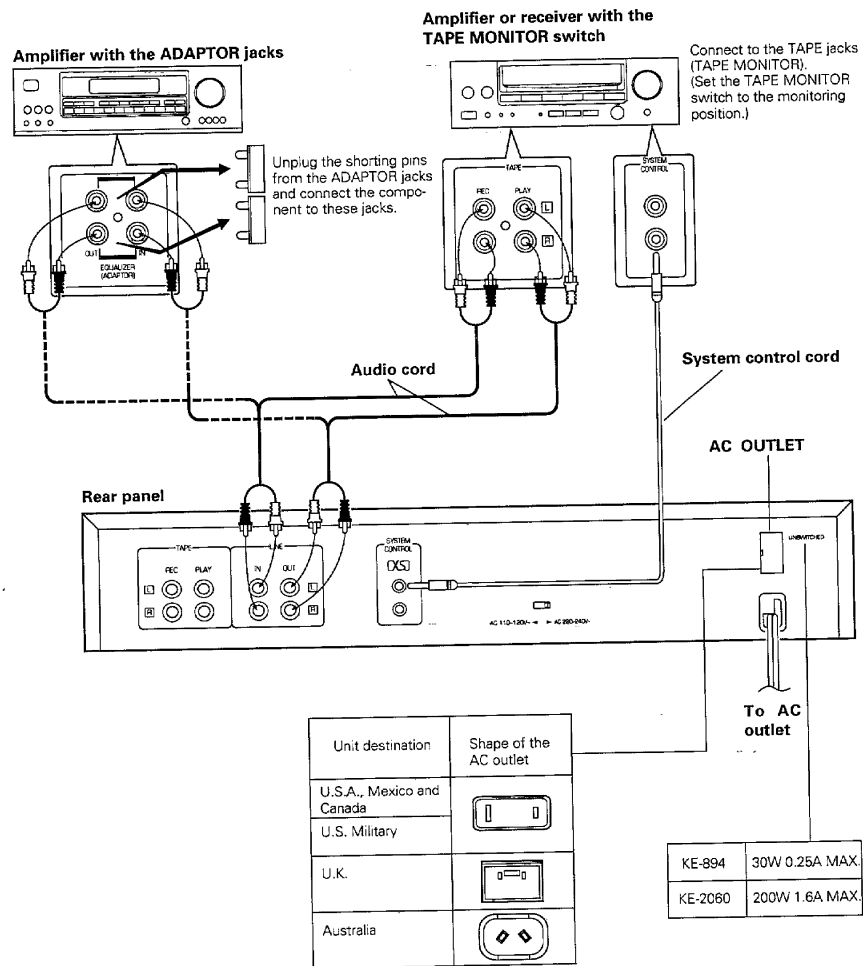

- Notes:
1. Connect all cords firmly. If connections are loose there could be loss of sound or noise produced.
  2. When plugging and unplugging connection cords, be sure to first remove the power cord from the AC outlet. Plugging/unplugging connection cords without removal of the power cord can cause malfunctions or damage to the unit.
  3. Do not connect up a power source which is larger than that indicated on the socket at the rear of the unit.

## ■ Connecting to cassette deck

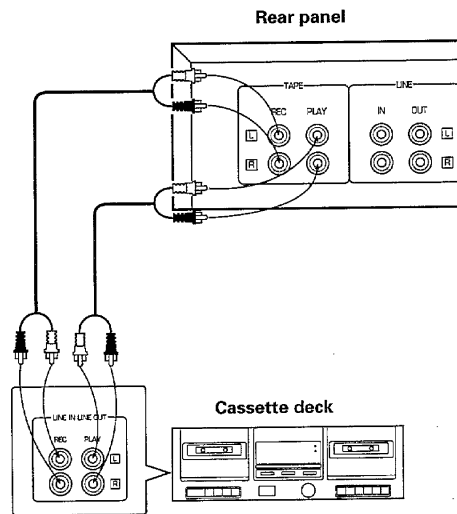

### System control connection

When connected to an amplifier or receiver having KENWOOD SYSTEM CONTROL terminals, system operation such as remote control is made possible. For details, refer to the instruction manual of the amplifier or receiver. If your amplifier or receiver is not equipped with the SYSTEM CONTROL terminals, do not connect anything to any SYSTEM CONTROL terminal. Do not connect the unit in any system configuration other than specified.

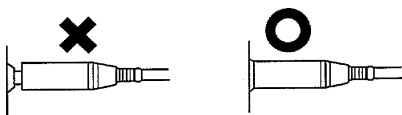

- Be sure to insert the system control cord plugs fully into the SYSTEM CONTROL terminals.
- If the system control cord and audio cords are not connected properly, the automatic system governing remote control and system functions will not operate.

# Controls and indicators

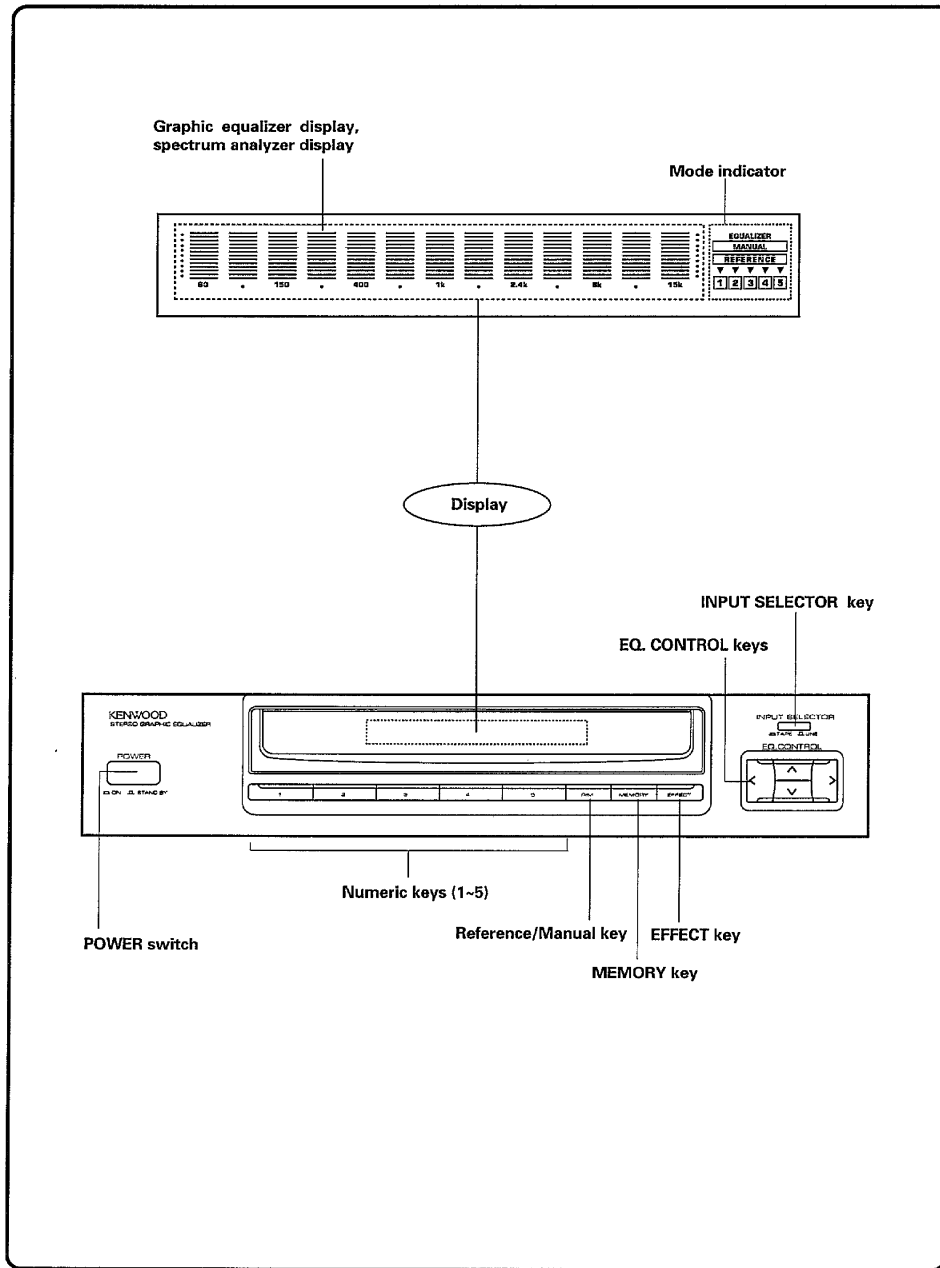



# Operating instructions

## ■ Using the equalizer effect

### Preparation:

Set the TAPE MONITOR switch of the amplifier or receiver connected to this unit.

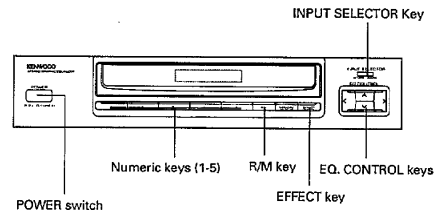

**1** Press the **POWER** switch of this unit to **ON**.

**2** Set the **INPUT SELECTOR** to **LINE**.

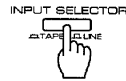

**3** Press the **EFFECT** key.

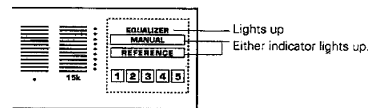

Lights up  
Either indicator lights up.

**4** Recall the equalizer patterns.

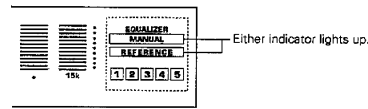

Either indicator lights up.

Reference mode: The **REFERENCE** indicator lights up.

Select from R1 to R5 (REFERENCE MEMO.).  
(See the list of equalizer patterns on page 10.)

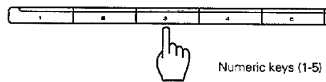

Numeric keys (1-5)

Manual mode: The **MANUAL** indicator lights up.

Select from M1 to M5 (MANUAL MEMO.).  
(See the list of equalizer patterns on page 10.)

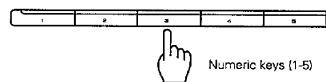

Numeric keys (1-5)

• In this mode, desired patterns can be created.  
(See "Storing Your Own Patterns" on page 12.)

### To cancel equalizer effect

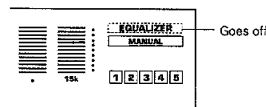

Goes off

• The pattern shown in the display does not change.

## ■ Equalizer pattern list

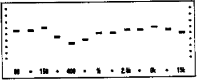
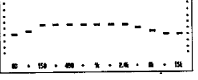
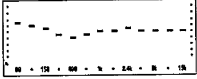
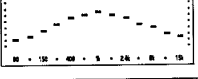
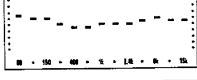
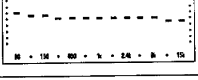
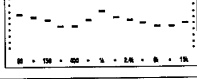
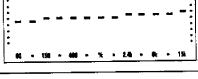
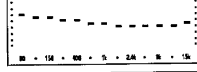
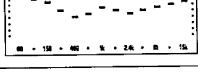
REFERENCE MEMO. (R1 to R5)	MANUAL MEMO. (M1 to M5) Presetting is possible in this mode.
R1: For recording sound source by enhancing sound quality for head-phone stereo. 	M1: To reduce very low noise or scratch noise during playback of analog records. 
R2: For recording sound source by enhancing sound quality for car stereo. 	M2: To enjoy the atmosphere of old jazz in the 1950's. 
R3: To produce powerful music such as rock or fusion with more liveliness. 	M3: For listening to music for a long time or playing background music. 
R4: To emphasize vocals. For any musical category. 	M4: To listen carefully to the detailed sound according to the source. 
R5: To produce soft sound by reducing stimulative mid-range and treble. 	M5: To produce exciting sound by emphasizing the very low range. 

## Display

### SPECTRUM ANALYZER display

Normally displays the spectrum analyzer.

Displays the frequency distribution of the music source being played back.

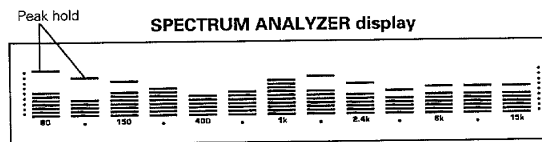

### GRAPHIC EQUALIZER display

Displays how each frequency is compensated.

The GRAPHIC EQUALIZER will be displayed for approximately 5 seconds upon the following operations while the SPECTRUM ANALYZER is being displayed.

1. When the power is switched ON.
2. When a key related to operation of the equalizer is pressed.

### GRAPHIC EQUALIZER display

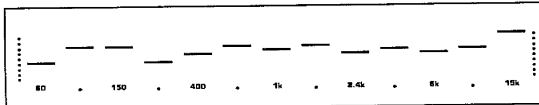

## ■ Functions of graphic equalizer

**Compensation for the audio characteristics of listening room**

The listening room may contain several objects. Some of them reflect sound and some absorb sound, thus the sound reaching your ears is considerably affected by these objects. In such cases, the graphic equalizer can be used to adjust the frequency response of the room for a flat response from low to high frequencies.

- Low frequencies are absorbed by beds, chairs, etc.
- High frequencies are absorbed by curtains, screens, etc.
- The room structure can cause the low frequencies to be unclear, or the sound level to increase or decrease depending on the frequency.

**Adjustment of sound to your individual taste**

When the reproduced sound contains several musical instruments and voices, the graphic equalizer allows you to enhance or attenuate the sound of specific instruments or voices.

Original, or ideal, speaker sound

Actual sound reaching the listener

### Sound equalization

#### • Super bass range (60 Hz)

When this control is moved up, the bass instrument (double bass, bass drums, or pipe organ, etc.) sound is increased. When the super bass sound is boomy, move this control down.

#### • Bass range (150 Hz)

Usually, the listening room resonance frequency is in this range. To eliminate bass resonance, move this control down.

#### • Mid-bass range (400 Hz)

This range is the basis of music. Whether the sound is rich or not, depends on this range. When the playback sound is not so good, move this control up.

#### • Mid range (1 kHz)

When this control is moved up or down, the baritone or soprano voice is emphasized/de-emphasized. This range is related to the "presence" of music.

#### • Mid-high range (2.4 kHz)

This range is related to stimulus and metallic sound. When this range is well compensated, vivid sound can be obtained.

#### • High range (6 kHz)

This frequency range is related to the hardness of the sound. When this control is moved up, strings or brass instruments, such as flutes or piccolos, are emphasized. When the control is moved down, the sound will become more smoothing.

#### • Super high range (15 kHz)

This frequency range is related to the details of the music. When this control is moved up, super high frequency instruments, such as triangles or cymbals, are emphasized, resulting in wide sound and echoes.

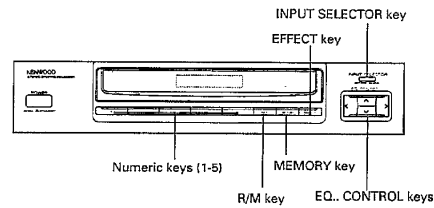

## ■ Storing your own patterns(M1~M5)

### 1 Create a desired equalizer pattern.

- ① Set the INPUT SELECTOR to LINE.



- ② Press the EFFECT key.

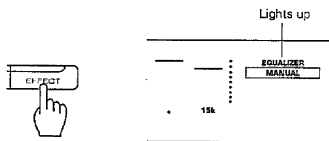

- ③ Select the frequency band to be adjusted.

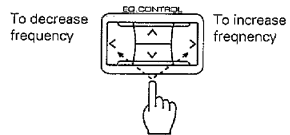

- ④ Adjust its level.

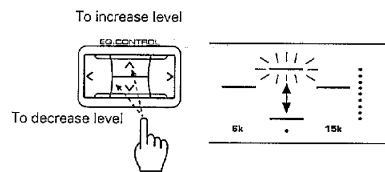

- ⑤ For each frequency band to be adjusted, repeat steps ③ and ④ above.

### 2 Store the equalizer pattern.

- ① Select MANUAL mode.

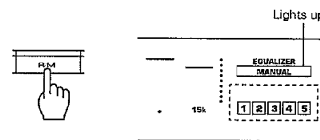

- ② Press the MEMORY key.

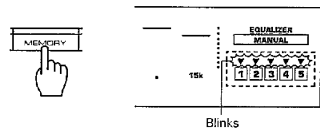

- ③ Press a numeric key (1 to 5).

Press a number key within 5 seconds after pressing the MEMORY key.

To store data to M3, press **3**.

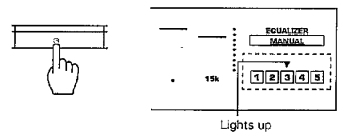

- Your equalizer pattern will be stored to the numeric key (1 to 5) you have pressed.
- In the same manner, up to five patterns can be stored.
- If a digit key (1 to 5) already has been assigned with equalizer pattern data, the old data will be replaced by the new data.

## ■ How to play tape with equalizer effect

### preparation:

Before proceeding to the following, connect a cassette deck as shown on page 7.

To initialize the setting patterns(MANUAL MEMO. M1 to M5 on page 10)after storing your own pattern:

#### ① Select MANUAL mode.

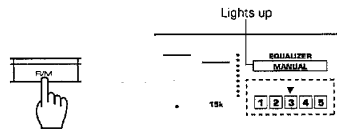

#### ② press the desired numeric key (1 to 5) more than 5 seconds.

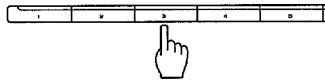

#### 1 Set the INPUT SELECTOR to TAPE.

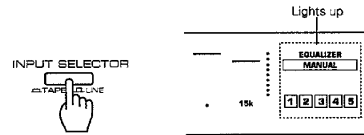

#### 2 Create a desired equalizer pattern.

(See pages 9 to 13 for how to create equalizer patterns.)

#### 3 Start playing the cassette deck.

## In case of difficulty

 **Caution: Read this page carefully to ensure safe operation.**

**What appears to be a malfunction may not always be serious. If your unit does not perform as expected, consult the table below to see if the problem can be corrected before seeking help from your dealer or service representative.**

Symptom	Cause	Remedy
No sound after switching the power ON.	<ul style="list-style-type: none"><li>• The cables are not correctly plugged in.</li></ul>	<ul style="list-style-type: none"><li>• Connect correctly by referring to "Connection" on page 6.</li></ul>
No equalizer effect.	<ul style="list-style-type: none"><li>• The EFFECT key has not been set to ON.</li></ul>	<ul style="list-style-type: none"><li>• Set the EFFECT key to ON.</li></ul>

**Notes:**

1. This system is microprocessor-controlled, so malfunction may occur due to external noise or interference noise. In such a case, unplug the power cord, plug it and turn power on again.
2. Do not use contact cleaners because it could cause a malfunction. Be specially careful against contact cleaners containing oil, for they may deform the plastic components.

# Specifications

## Performance

Equalizer characteristics variable range .....	±10 dB / ±2 dB
Individual channel adjust (Hz) .....	60, 150, 400, 1k, 2.4k, 6k, 15k
Total harmonic distortion (at 1 kHz, Flat) .....	0.01 %
Gain .....	0 dB
Frequency response (at flat) .....	20 Hz ~ 20 kHz, +1.5 dB
Signal to noise ratio (IHF66) .....	92 dB
Input impedance .....	47 kΩ
Maximum output voltage (at 0.01 % T.H.D.) .....	4.5 V
Output impedance .....	2 kΩ

## General

Power consumption .....	15 W
AC outlet	
UNSWITCHED .....	1(30W 0.25A MAX.) (KE-894 For U.S.A. and Mexico only) 1(30W MAX.) (KE-894 For other countries) 1(200W 1.6A MAX.) (KE-2060 For U.S.A. and Mexico only) 1(200W MAX.) (KE-2060 For other countries)
Dimensions .....	W: 440 mm (17-5/16") H: 89 mm (3- 1/ 2") D: 250 mm (9-13/16")
Weight (Net) .....	2.9 kg (6.4 lb)

### Note:

KENWOOD follows a policy of continuous advancements in development. For this reason specifications may be changed without notice.

### For the U.S.A.

#### FCC WARNING:

This equipment may generate or use radio frequency energy. Changes or modifications to this equipment may cause harmful interference unless the modifications are expressly approved in the instruction manual. The user could lose the authority to operate this equipment if an unauthorized change or modification is made.

#### NOTE:

This equipment has been tested and found to comply with limits for a Class B digital device, pursuant to Part 15 of the FCC Rules. These limits are designed to provide reasonable protection against harmful interference in a residential installation. This equipment may cause harmful interference to radio communications, if it is not installed and used in accordance with the instructions. However, there is no guarantee that interference will not occur in a particular installation. If this equipment does cause harmful interference to radio or television reception, which can be determined by turning the equipment off and on, the user is encouraged to try to correct the interference by one or more of the following measures:

- Reorient or relocate the receiving antenna.
- Increase the separation between the equipment and receiver.
- Connect the equipment into an outlet on a circuit different from that to which the receiver is connected.
- Consult the dealer or an experienced radio/TV technician for help.

KENWOOD